

P6960HCD Probe

Instructions

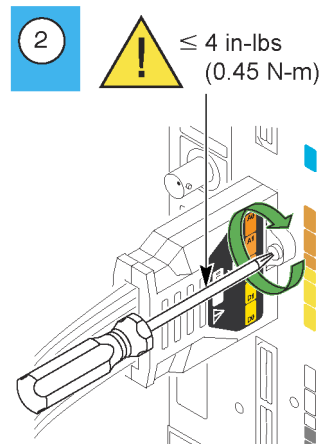
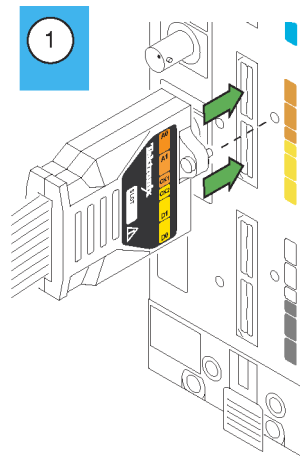

Labels

Use the illustrations on the back of this page to apply your labels to the probe connectors.

Contacting Tektronix

Tektronix, Inc.

14200 SW Karl Braun Drive

PO Box 500

Beaverton, OR 97077

USA

For product information, sales, service, and technical support:

- In North America, call 1-800-833-9200.
- Worldwide, visit www.tektronix.com to find contacts in your area

1

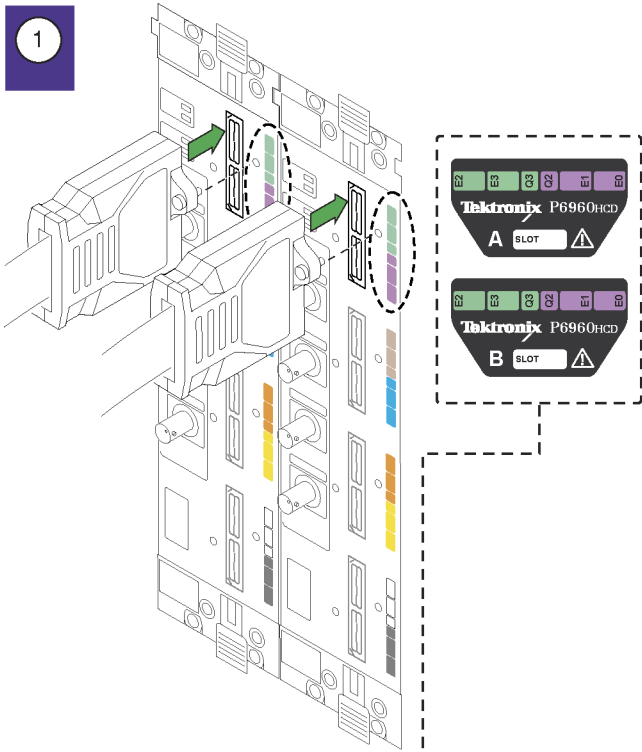

2

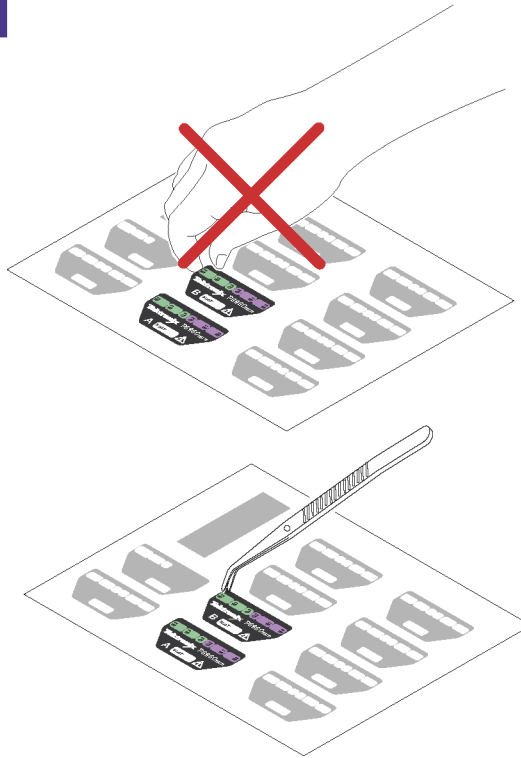

4

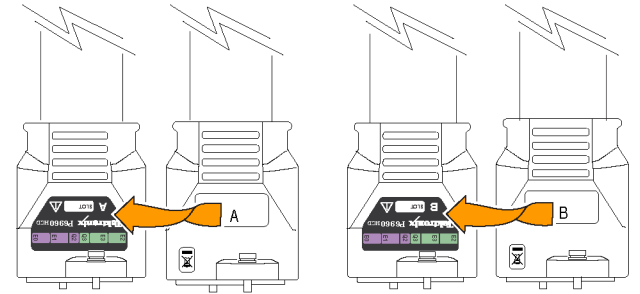

3

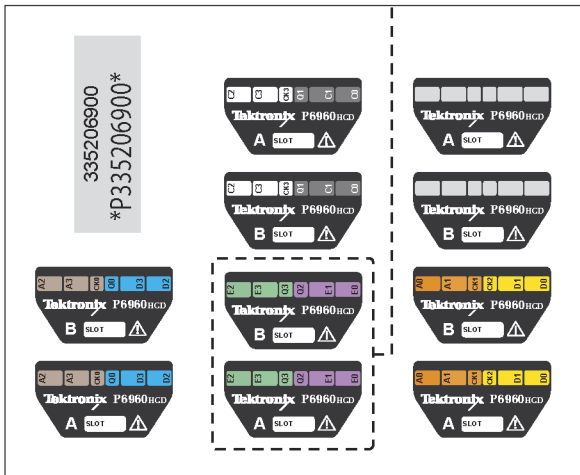
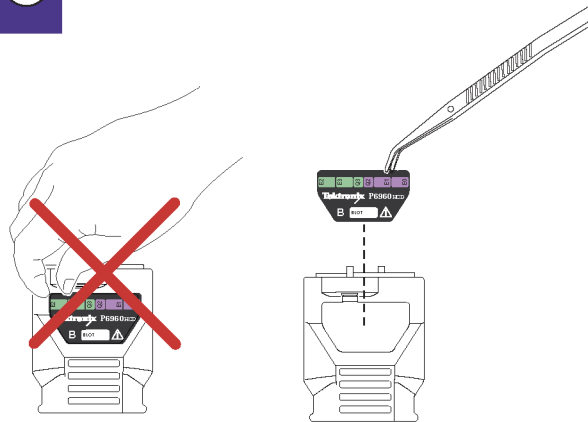

www.tektronix.com/manuals
 Model P6960HCD